

# 1260 SWITCHING CARD

## 1260-700 PROTOTYPING MODULE PLUG-IN

PUBLICATION NO. 980824-700

**RACAL INSTRUMENTS**

**United States**

(Corporate Headquarters and Service Center)  
4 Goodyear Street, Irvine, CA 92618  
Tel: (800) 722-2528, (949) 859-8999; Fax: (949) 859-7139

5730 Northwest Parkway Suite 700, San Antonio, TX 78249  
Tel: (210) 699-6799; Fax: (210) 699-8857

**Europe**

(European Headquarters and Service Center)  
18 Avenue Dutartre, 78150 LeChesnay, France  
Tel: +33 (0)1 39 23 22 22; Fax: +33 (0)1 39 23 22 25

29-31 Cobham Road, Wimborne, Dorset BH21 7PF, United Kingdom  
Tel: +44 (0) 1202 872800; Fax: +44 (0) 1202 870810

Via Milazzo 25, 20092 Cinisello B, Milan, Italy  
Tel: +39 (0)2 6123 901; Fax: +39 (0)2 6129 3606

Technologie Park, Friedrich Ebert Strasse, 51429 Bergisch Gladbach, Germany  
Tel: +49 (0) 2204 844200; Fax: +49 (0) 2204 844219

[info@racalinstruments.com](mailto:info@racalinstruments.com)  
[sales@racalinstruments.com](mailto:sales@racalinstruments.com)  
[helpdesk@racalinstruments.com](mailto:helpdesk@racalinstruments.com)  
<http://www.racalinstruments.com/>



---

**PUBLICATION DATE: October 14, 2004**

Copyright 2002 by Racal Instruments, Inc. Printed in the United States of America. All rights reserved.  
This book or parts thereof may not be reproduced in any form without written permission of the publisher.

---

---

## THANK YOU FOR PURCHASING THIS RACAL INSTRUMENTS PRODUCT.

---

---

For this product, or any other Racal Instruments product that incorporates software drivers, you may access our web site to verify and/or download the latest driver versions. The web address for driver downloads is:

<http://www.racalinstruments.com/downloads>

If you have any questions about software driver downloads or our privacy policy, please contact us at

[info@racalinstruments.com](mailto:info@racalinstruments.com).

---

---

## WARRANTY STATEMENT

---

---

All Racal Instruments, Inc. products are designed and manufactured to exacting standards and in full conformance to Racal's ISO 9000\2000 procedures.

This warranty does not apply to defects resulting from any modification(s) of any product or part without Racal Instruments express written consent, or misuse of any product or part. The warranty also does not apply to fuses, software, non-rechargeable batteries, damage from battery leakage, or problems arising from normal wear, such as mechanical relay life, or failure to follow instructions.

This warranty is in lieu of all other warranties, expressed or implied, including any implied warranty of merchantability or fitness for a particular use. The remedies provided herein are buyer's sole and exclusive remedies.

For the specific terms of your standard warranty, or optional extended warranty or service agreement, contact your Racal customer service advisor. Please have the following information available to facilitate service.

1. Product serial number
2. Product model number
3. Your company and contact information

You may contact your customer service advisor by:

E-Mail:	<a href="mailto:Helpdesk@racalinstruments.com">Helpdesk@racalinstruments.com</a>	
Telephone:	+1 800 722 3262	(USA)
	+44(0) 8706 080134	(UK)
Fax:	+1 949 859 7309	(USA)
	+44(0) 1628 662017	(UK)

---

---

## RETURN of PRODUCT

---

---

Authorization is required from Racal Instruments before you send us your product for service or calibration. Call your nearest Racal Instruments support facility. A list is located on the last page of this manual. If you are unsure where to call, contact Racal Instruments, Inc. Customer Support Department in Irvine, California, USA at 1-800-722-3262 or 1-949-859-8999 or via fax at 1-949-859-7139. We can be reached at: [helpdesk@racalstruments.com](mailto:helpdesk@racalstruments.com).

---

---

## PROPRIETARY NOTICE

---

---

This document and the technical data herein disclosed, are proprietary to Racal Instruments, and shall not, without express written permission of Racal Instruments, be used, in whole or in part to solicit quotations from a competitive source or used for manufacture by anyone other than Racal Instruments. The information herein has been developed at private expense, and may only be used for operation and maintenance reference purposes or for purposes of engineering evaluation and incorporation into technical specifications and other documents which specify procurement of products from Racal Instruments.

---

---

## DISCLAIMER

---

---

Buyer acknowledges and agrees that it is responsible for the operation of the goods purchased and should ensure that they are used properly and in accordance with this handbook and any other instructions provided by Seller. Racal Instruments products are not specifically designed, manufactured or intended to be used as parts, assemblies or components in planning, construction, maintenance or operation of a nuclear facility, or in life support or safety critical applications in which the failure of the Racal Instruments product could create a situation where personal injury or death could occur. Should Buyer purchase Racal Instruments product for such unintended application, Buyer shall indemnify and hold Racal Instruments, its officers, employees, subsidiaries, affiliates and distributors harmless against all claims arising out of a claim for personal injury or death associated with such unintended use.

---

# FOR YOUR SAFETY

---

Before undertaking any troubleshooting, maintenance or exploratory procedure, read carefully the **WARNINGS** and **CAUTION** notices.



**CAUTION**  
RISK OF ELECTRICAL SHOCK  
DO NOT OPEN



This equipment contains voltage hazardous to human life and safety, and is capable of inflicting personal injury.



If this instrument is to be powered from the AC line (mains) through an autotransformer, ensure the common connector is connected to the neutral (earth pole) of the power supply.



Before operating the unit, ensure the conductor (green wire) is connected to the ground (earth) conductor of the power outlet. Do not use a two-conductor extension cord or a three-prong/two-prong adapter. This will defeat the protective feature of the third conductor in the power cord.



Maintenance and calibration procedures sometimes call for operation of the unit with power applied and protective covers removed. Read the procedures and heed warnings to avoid “live” circuit points.

Before operating this instrument:

1. Ensure the proper fuse is in place for the power source to operate.
2. Ensure all other devices connected to or in proximity to this instrument are properly grounded or connected to the protective third-wire earth ground.

If the instrument:

- fails to operate satisfactorily
- shows visible damage
- has been stored under unfavorable conditions
- has sustained stress

Do not operate until, performance is checked by qualified personnel.

# Racal Instruments

## EC Declaration of Conformity

We

Racal Instruments Inc.  
4 Goodyear Street  
Irvine, CA 92718

declare under sole responsibility that the

**1260-700 Prototype Plug In Module  
P/N 407827**

conforms to the following Product Specifications:

**Safety:** EN61010-1:1993+A2:1995

**EMC:** EN61326:1997+A1:1998

**Supplementary Information:**

The above specifications are met when the product is installed in a Racal Instruments certified mainframe with faceplates installed over all unused slots, as applicable

The product herewith complies with the requirements of the Low Voltage Directive 73/23/EEC and the EMC Directive 89/336/EEC.

Irvine, CA, November 11, 2002



Karen Evensen, Engineering Director

This page was left intentionally blank.

## Table of Contents

Chapter 1 .....	1-1
SPECIFICATIONS .....	1-1
Introduction .....	1-1
Part Numbers, Options and Ordering Information .....	1-2
Main Board - Introduction .....	1-3
Main Board - Specifications .....	1-4
Main Board - Power Dissipation / Cooling Guidelines .....	1-5
Prototype Board – Introduction .....	1-6
Interface Connections .....	1-7
Power and Ground Connections .....	1-8
Prototype Board - Specifications .....	1-12
Prototype Board - Power Dissipation / Cooling Guidelines .....	1-13
Component Placement .....	1-13
Component Height and Keepout Area .....	1-13
About MTBF .....	1-14
1260-700 Block Diagram .....	1-14
Chapter 2 .....	2-1
INSTALLATION INSTRUCTIONS .....	2-1
Unpacking and Inspection .....	2-1
Reshipment Instructions .....	2-1
Assembly .....	2-1
Installation .....	2-2

Optional Extender Board .....	2-2
Module Configuration .....	2-3
Front Panel Connectors.....	2-4
Mating Connectors.....	2-4
<b>Chapter 3</b> .....	<b>3-1</b>
MODULE OPERATION .....	3-1
Setting the Module Address .....	3-1
Operating Modes.....	3-2
Operating In Message-Based Mode.....	3-4
Port Descriptors For The 1260-700 .....	3-4
Reply To The MOD:LIST? Command.....	3-5
Operating The 1260-700 in Register-Based Mode .....	3-6
1260-700 Example Code .....	3-14
<b>Chapter 4</b> .....	<b>4-1</b>
DRAWINGS.....	4-1
<b>Chapter 5</b> .....	<b>5-1</b>
OPTIONAL ASSEMBLIES .....	5-1
<b>Chapter 6</b> .....	<b>6-1</b>
Product Support .....	6-1
Warranty .....	6-1
Support Offices .....	6-2
Repair and Calibration Request Form .....	6-3



## List of Figures

Figure 1-1, The 1260-700 .....	1-2
Figure 1-2, 1260-700 Configuration .....	1-3
Figure 1-3, 1260-700 Prototype Board Layout .....	1-6
Figure 1-4, Prototype Board Port Interface Pin Assignments .....	1-8
Figure 1-5, 1260-700 Prototype Board Detail .....	1-9
Figure 1-6a, 1260-700 Prototype Power Connection Example .....	1-10
Figure 1-6b, 1260-700 Prototype Power Connection Example .....	1-11
Figure 1-7, 1260-700 Block Diagram .....	1-14
Figure 2-1, Attachment Bracket Locations .....	2-2
Figure 2-2, Optional Extender Board .....	2-3
Figure 2-3, Front Panel Connector Pin Numbering .....	2-5
Figure 3-1a, Front View – Module Addresses for 1 through 6 in a 1260-100 Carrier .....	3-1
Figure 3-1b, Front View – Module Addresses for 7 through 12 in a 1260-100 Carrier .....	3-2
Figure 3-2, Numbering of Switch Plug-In Slots in a 1256 Chassis .....	3-3
Figure 3-3, Message-Based Mode of Operation .....	3-3
Figure 3-4, Register-Based Mode of Operation .....	3-3

**List of Tables**

Table 1-1, Prototype Board Interface Pin Assignments..... 1-7

Table 3-1, Register Offset Addresses of the 1260-700 Module ..... 3-8

Table 3-2, ID Register Functionality of the 1260-700 ..... 3-8

Table 3-3, Ports A-F Register Functionality of the 1260-700 Module ..... 3-9

Table 3-4, Ports G-L Register Functionality of the 1260-700 Module.....3-10

Table 3-5, Control Register 1 Functionality of the 1260-700 Module.....3-10

Table 3-6, Control Register 2 Functionality of the 1260-700 Module.....3-11

Table 3-7, Control Register 3 Functionality of the 1260-700 Module.....3-11

Table 3-8, EPROM Descriptor Functionality of the 1260-700 Module .....3-12

# Chapter 1

## SPECIFICATIONS

---

### Introduction

The 1260-700 is a plug-in prototyping card developed for the Racal Instruments 1260-100 Adapt-a-Switch™ Carrier or 1256 Switching System Mainframe. It allows the user to design and build his or her own test or measurement circuit on an easy-to-use interface platform. The module provides 88 TTL-compatible digital I/O lines to interface with the user's custom circuitry. The 1260-700 has a detachable prototyping area that provides approximately 17 square inches of available board space.

The 1260-700 includes the following features:

- Standard Adapt-a-Switch™ plug-in design, providing for ease of replacement.
- Detachable prototyping area providing 17 square inches of board space.
- Data-Driven embedded descriptor, allowing immediate use with any Option-01T switch controller, regardless of firmware revision level.

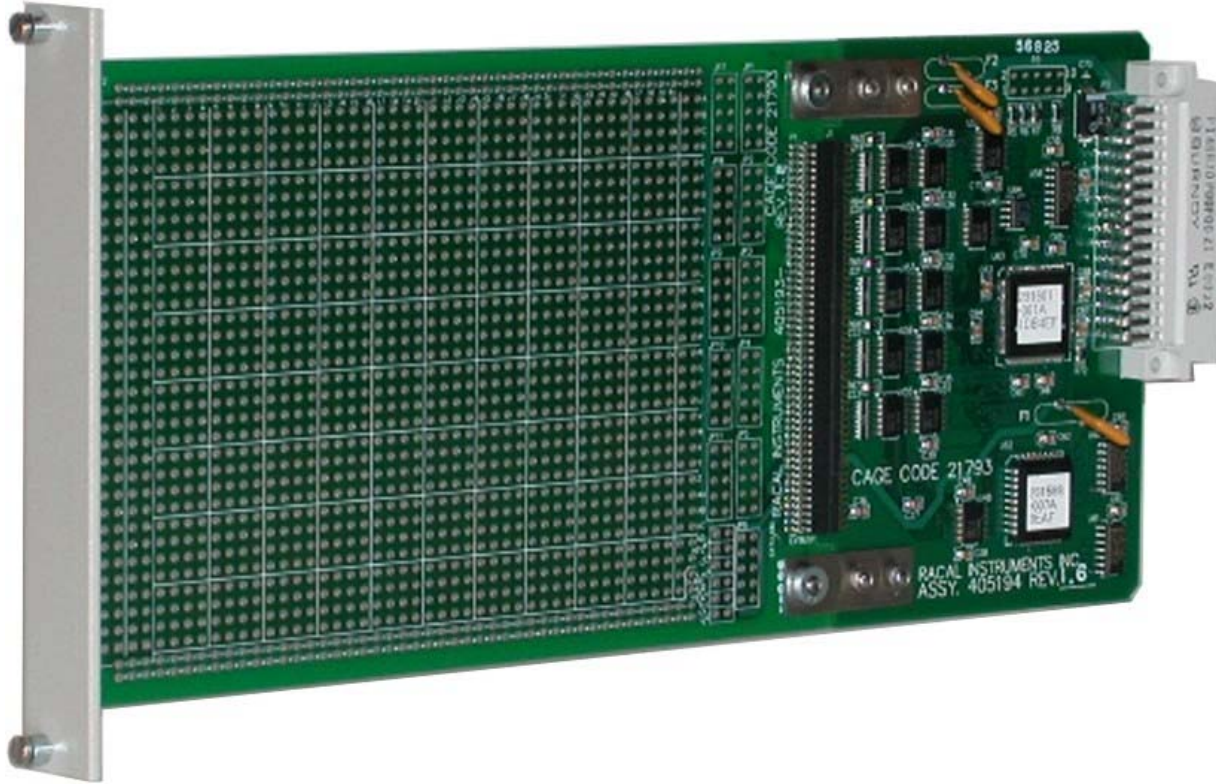

**Figure 1-1, The 1260-700**

## Part Numbers, Options and Ordering Information

The 1260-700 can be ordered as an easy-to-use kit or as individual pieces as needed depending upon the application. Please refer to **Figure 1-2**. The following Part Numbers are available as standard products:

407827	1260-700 Adapt-a-Switch™ Prototype Module. Includes: 1260-700 Main board (TTL Interface) 1260-700 User Prototype Board 1260-700 Blank Front Panel kit User Manual w/ software drivers
405194	1260-700 Main board (TTL Interface)
405193	1260-700 User Prototype Board Includes: Prototype Board with 100-pin interface connector installed
602559-000	Prototype Board 100-Pin interface connector
407830-001	1260-700 Blank Front Panel kit
407830-002	1260-700 64-Pin DIN Connector Front Panel kit
407830-003	1260-700 160-Pin DIN Connector Front Panel kit

Mating Connectors and Kits

- 602004      64-Pin DIN IDC Connector
- 602159-064    64-Pin DIN Crimp Connector Body
- 602159-900    DIN Crimp Pins for 64-Pin Connector Body
- 407664      160-Pin DIN Connector Kit with Pins
- 407408-001    160-Pin DIN Cable Assembly, 6ft, 24AWG

**Extender Board**

- 405135      Adapt-a-Switch™ Extender Board

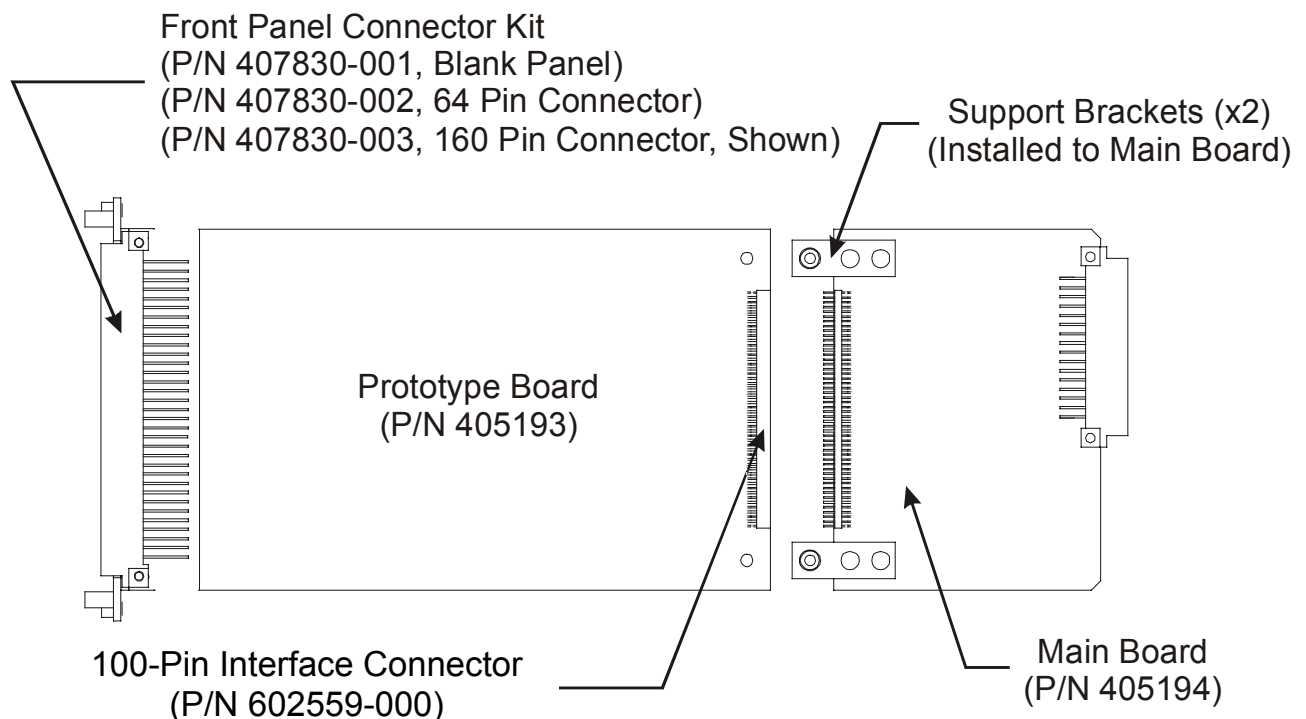

**Figure 1-2, 1260-700 Configuration**

## Main Board - Introduction

The 1260-700 is comprised of two main pieces: the main board and the prototyping board as shown in **Figure 1-2**. The Main board (Racal P/N 405194) contains the Adapt-a-Switch™ programming interface to the controller and the TTL interface to the user Prototype Board.

The main board provides 88 TTL-compatible Digital Input/output (DIO) interface lines to the user prototype board along with handshaking lines that may be used to support synchronous data transfers.

The 88 DIO lines are arranged as 11 groups of 8 bits each. At any given time, each group may be designated as either an input or as an output.

## Main Board - Specifications

### Specifications at Interface to User Prototype Board

Chan. Output Current	±6 mA maximum
Min. High Output Voltage	≥ 3.8 VDC @ -6 mA, Vcc=4.5V
Max. Low Output Voltage	≤ 0.33 VDC @ 6 mA, Vcc=4.
Min. High Input Voltage	≥ 2.0 VDC
Max. Low Input Voltage	≤ 0.8 VDC
Max. Chan. Input Voltage	5.5 VDC
Available I/O Channels	88 Bi-directional I/O available to the prototype area
Channel Synchronization	Asynchronous, Synchronous or Mixed
Synchronous Trigger	User Programmable Handshake Polarity
Synchronous Busy	User Programmable Handshake Polarity
Power Requirements (Available for User prototype Area)	+5 VDC at 1.5 A maximum +12V at 1 A (1260-100 platform only) +24V at 1 A (1260-100 platform only) 20 Watts total at 30°C
Cooling	See "Power Dissipation / Cooling Guidelines"

### General Specifications (Main Board Only)

Shock	30g, 11 ms, ½ sine wave
Vibration	0.013 in. P-P, 5-55 Hz
Bench Handling	4 in., 45°
Temperature	Operating        0°C to +55°C Non-operating   -40°C to +75°C
Relative Humidity	85% + 5% non-condensing at < 30°C

Altitude	Operating 10,000 feet Non-operating 15,000 feet
Power Requirements (Main Board Only)	+5 VDC @ 1 A maximum with all channels sourcing maximum loads
Weight	3 oz. (85g)
Mean Time Between Failures (MTBF)	>100,000 hours (MIL-HDBK-217E)
Mean Time to Repair	< 5 minutes (MTTR)

## Main Board - Power Dissipation / Cooling Guidelines

The cooling for the 1260-700 Adapt-a-Switch™ Prototyping board is dependent upon the ambient temperature and allowable heat rise for the circuitry. When installed in a 1256 Chassis or a 1260-100 Carrier, the mainboard will receive sufficient cooling even with all drivers in the ON state. The following Table and figure may be used as a guide in determining the allowable thermal load in the prototyping area. It is recommended that the board temperature not be allowed to rise above 55°C. Local heat sinking should be employed for devices with concentrated heat loads.

Ambient Temp (°C)	Maximum Allowable Temp Rise (°C)	Allowable Power Dissipation (W)
25	30	20
30	25	20
35	20	16
45	10	8
55	0	0

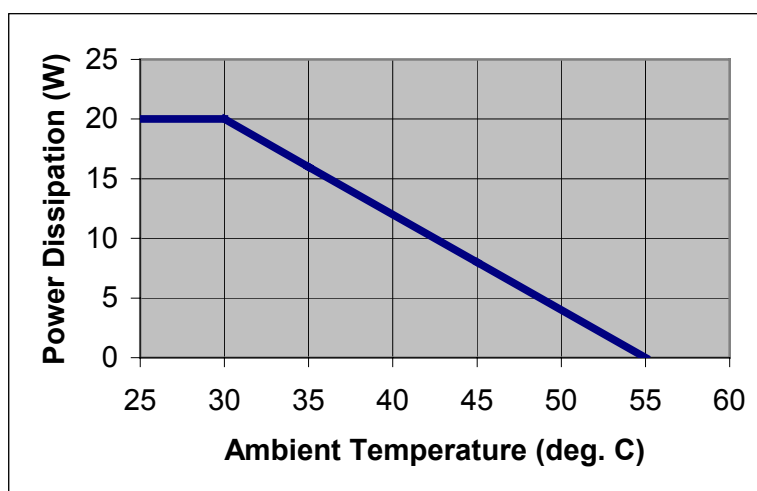

## Prototype Board – Introduction

The 1260-700 is comprised of two main pieces; The main board and the prototyping board as shown in **Figure 1-2**. The Prototype Board (Racal P/N 405193) provides approximately 17 square inches of prototyping area available for custom user circuitry.

The area available is laid out as a 0.1" x 0.1" grid so as to accommodate most common ICs, circuit adapters or chip carriers. Additionally, the prototyping area provides easy access to +5 Volts, ground and to the eleven 8-bit DIO ports.

If the 1260-700 is used in a 1260-100 VXI, Adapt-a-Switch™ Carrier, then the 1260-700 also has access to +12 Volts and +24 Volts.

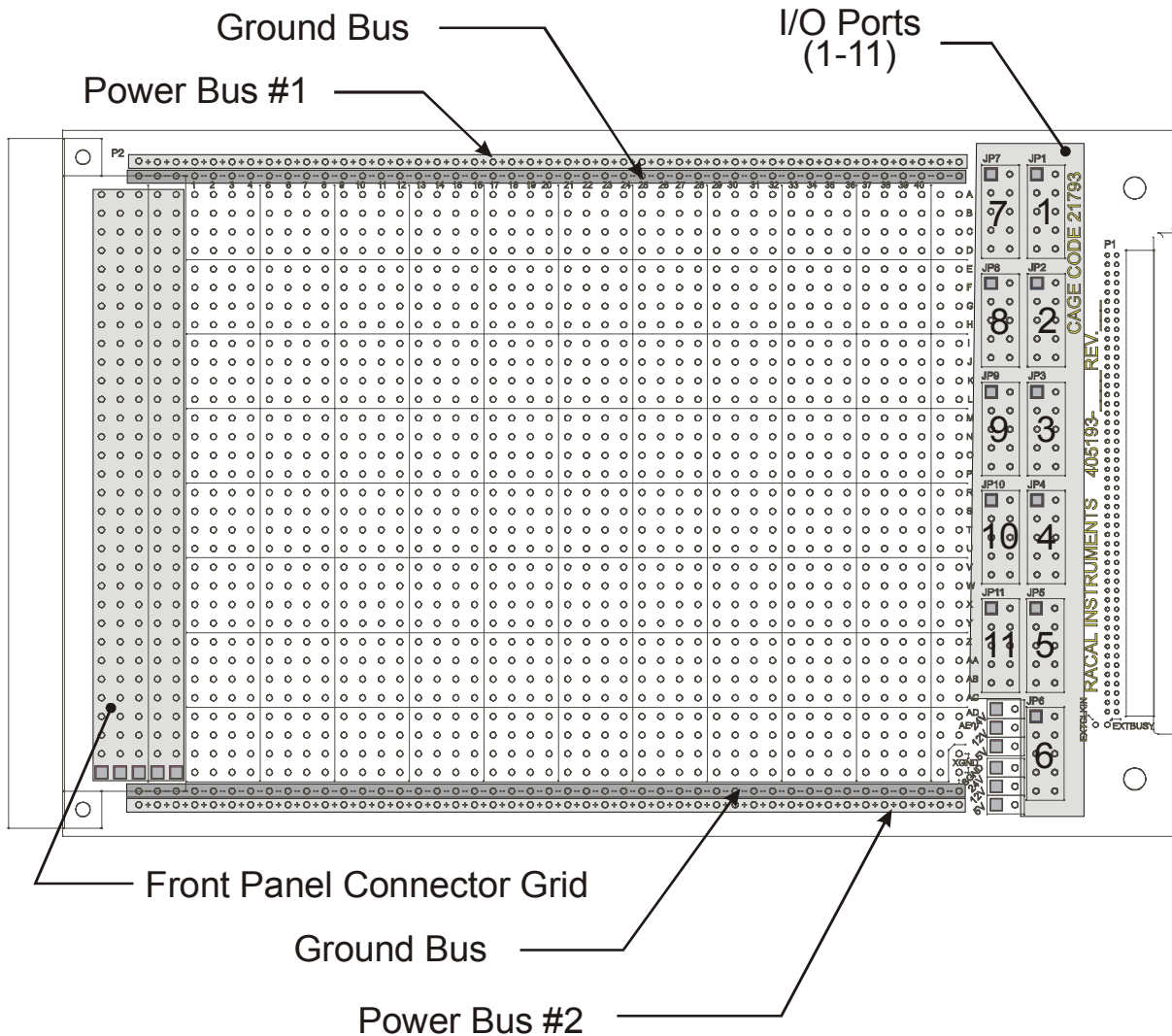

**Figure 1-3, 1260-700 Prototype Board Layout**



Power and ground are bused along the lengths of the prototyping area for easy access. Additionally, the prototyping area has a solid ground plane that may be connected to either the internal signal ground or to an external ground. Please see the section below regarding Power and Ground Connections.

The layout of the 1260-700 Prototype board is shown in **Figure 1-3**.

## Interface Connections

The main board interconnects with the prototype board via a 100 pin, high density connector. This connector delivers the eleven 8 bit ports of digital I/O, power, ground and handshaking lines to the prototyping area. The pin outs for the 100 pin connector are shown in **Table 1-1**. On the prototype board itself, the eleven 8-bit ports are available, along with +5V and ground, on eleven dual-row header patterns. A detail is shown in **Figure 1-4**.

**Table 1-1, Prototype Board Interface Pin Assignments**

A1	Port 0, Bit 0
A2	Port 0, Bit 1
A3	Port 0, Bit 2
A4	Port 0, Bit 3
A5	Port 0, Bit 4
A6	Port 0, Bit 5
A7	Port 0, Bit 6
A8	Port 0, Bit 7
A9	Port 1, Bit 0
A10	Port 1, Bit 1
A11	Port 1, Bit 2
A12	Port 1, Bit 3
A13	Port 1, Bit 4
A14	Port 1, Bit 5
A15	Port 1, Bit 6
A16	Port 1, Bit 7
A17	Port 2, Bit 0
A18	Port 2, Bit 1
A19	Port 2, Bit 2
A20	Port 2, Bit 3
A21	Port 2, Bit 4
A22	Port 2, Bit 5
A23	Port 2, Bit 6
A24	Port 2, Bit 7
A25	Port 3, Bit 0
A26	Port 3, Bit 1
A27	Port 3, Bit 2
A28	Port 3, Bit 3
B1	Port 6, Bit 0
B2	Port 6, Bit 1
B3	Port 6, Bit 2
B4	Port 6, Bit 3
B5	Port 6, Bit 4
B6	Port 6, Bit 5
B7	Port 6, Bit 6
B8	Port 6, Bit 7
B9	Port 7, Bit 0
B10	Port 7, Bit 1
B11	Port 7, Bit 2
B12	Port 7, Bit 3
B13	Port 7, Bit 4
B14	Port 7, Bit 5
B15	Port 7, Bit 6
B16	Port 7, Bit 7
B17	Port 8, Bit 0
B18	Port 8, Bit 1
B19	Port 8, Bit 2
B20	Port 8, Bit 3
B21	Port 8, Bit 4
B22	Port 8, Bit 5
B23	Port 8, Bit 6
B24	Port 8, Bit 7
B25	Port 9, Bit 0
B26	Port 9, Bit 1
B27	Port 9, Bit 2
B28	Port 9, Bit 3

A29	Port 3, Bit 4
A30	Port 3, Bit 5
A31	Port 3, Bit 6
A32	Port 3, Bit 7
A33	Port 4, Bit 0
A34	Port 4, Bit 1
A35	Port 4, Bit 2
A36	Port 4, Bit 3
A37	Port 4, Bit 4
A38	Port 4, Bit 5
A39	Port 4, Bit 6
A40	Port 4, Bit 7
A41	Port 5, Bit 0
A42	Port 5, Bit 1
A43	Port 5, Bit 2
A44	Port 5, Bit 3
A45	Port 5, Bit 4
A46	Port 5, Bit 5
A47	Port 5, Bit 6
A48	Port 5, Bit 7
A49	External Busy
A50	Ground

B29	Port 9, Bit 4
B30	Port 9, Bit 5
B31	Port 9, Bit 6
B32	Port 9, Bit 7
B33	Port 10, Bit 0
B34	Port 10, Bit 1
B35	Port 10, Bit 2
B36	Port 10, Bit 3
B37	Port 10, Bit 4
B38	Port 10, Bit 5
B39	Port 10, Bit 6
B40	Port 10, Bit 7
B41	+5 Volts
B42	+5 Volts
B43	Ground
B44	+12 Volts
B45	+12 Volts
B46	+24 Volts
B47	+24 Volts
B48	Ground
B49	External Clock In
B50	Ground

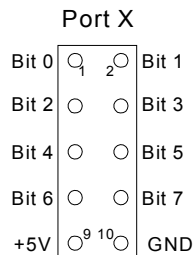

**Figure 1-4, Prototype Board Port Interface Pin Assignments**

## Power and Ground Connections

The 1260-700 Prototyping Board was designed to provide a great deal of flexibility in its layout and usage.

Running along the sides of the prototyping area are power and ground buses. These may be connected in a variety of ways by installing jumper wires at the appropriate points. Please refer to the diagrams in **Figure 1-5** and **Figure 1-6**.

The internal ground plane and ground bus may be connected to either the internal signal ground or to an external ground connection. The internal signal ground is the digital ground from the main board. This is the reference ground for the digital I/O

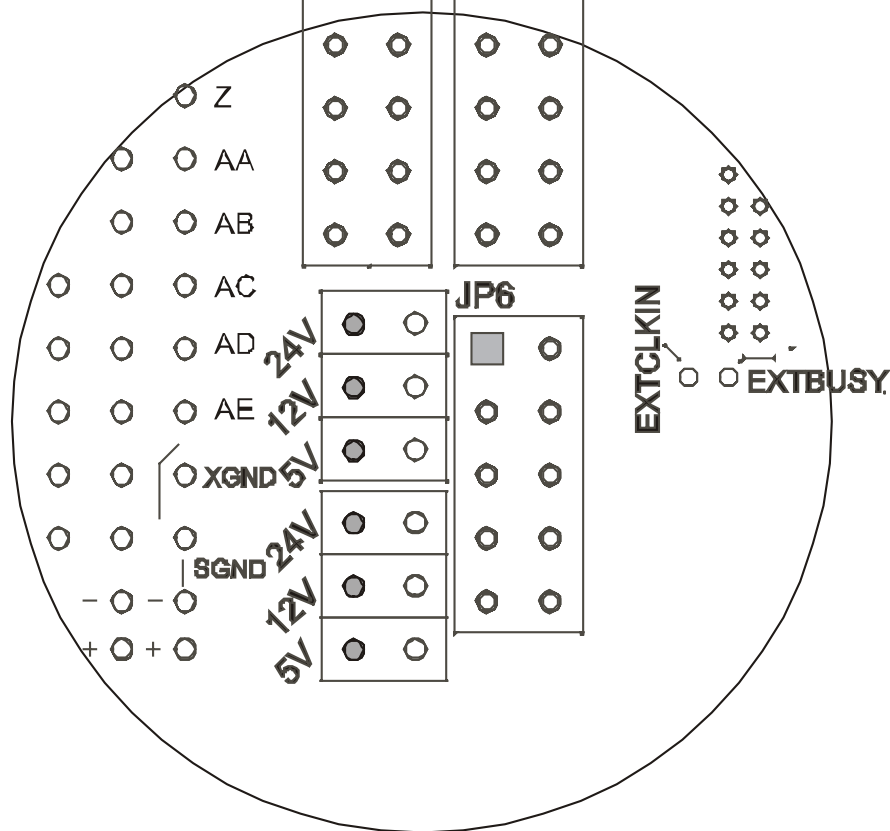
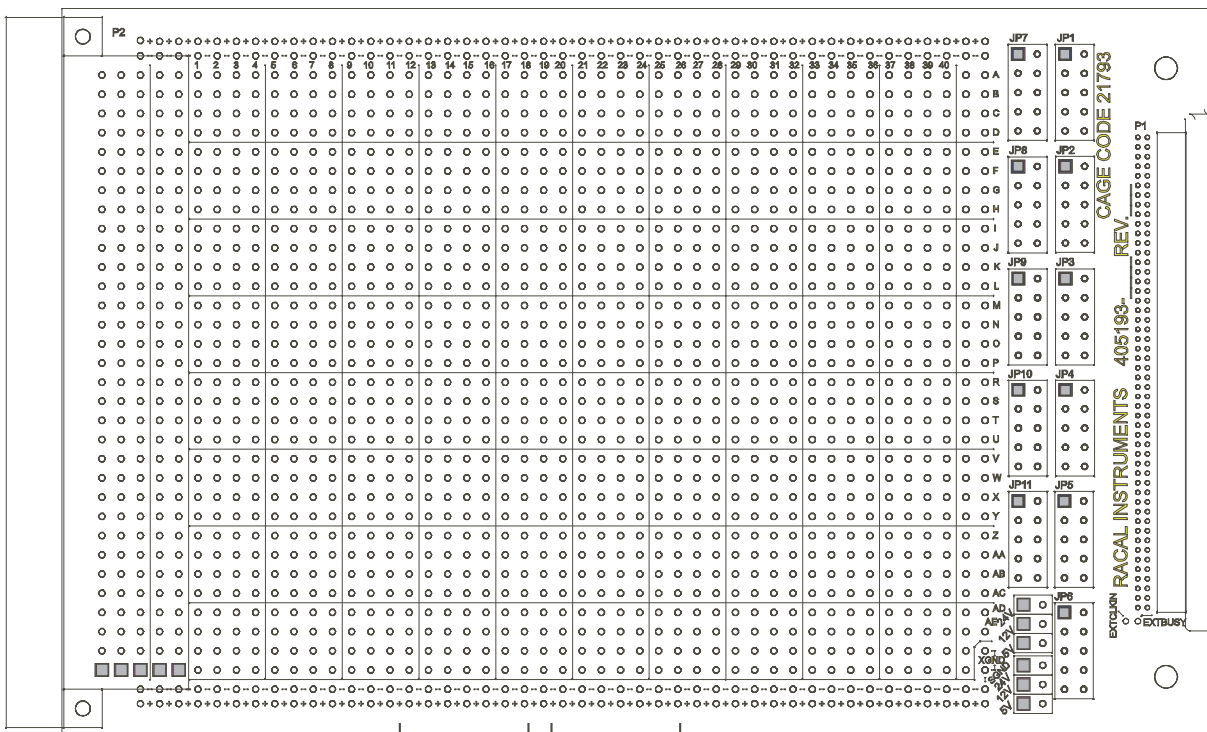

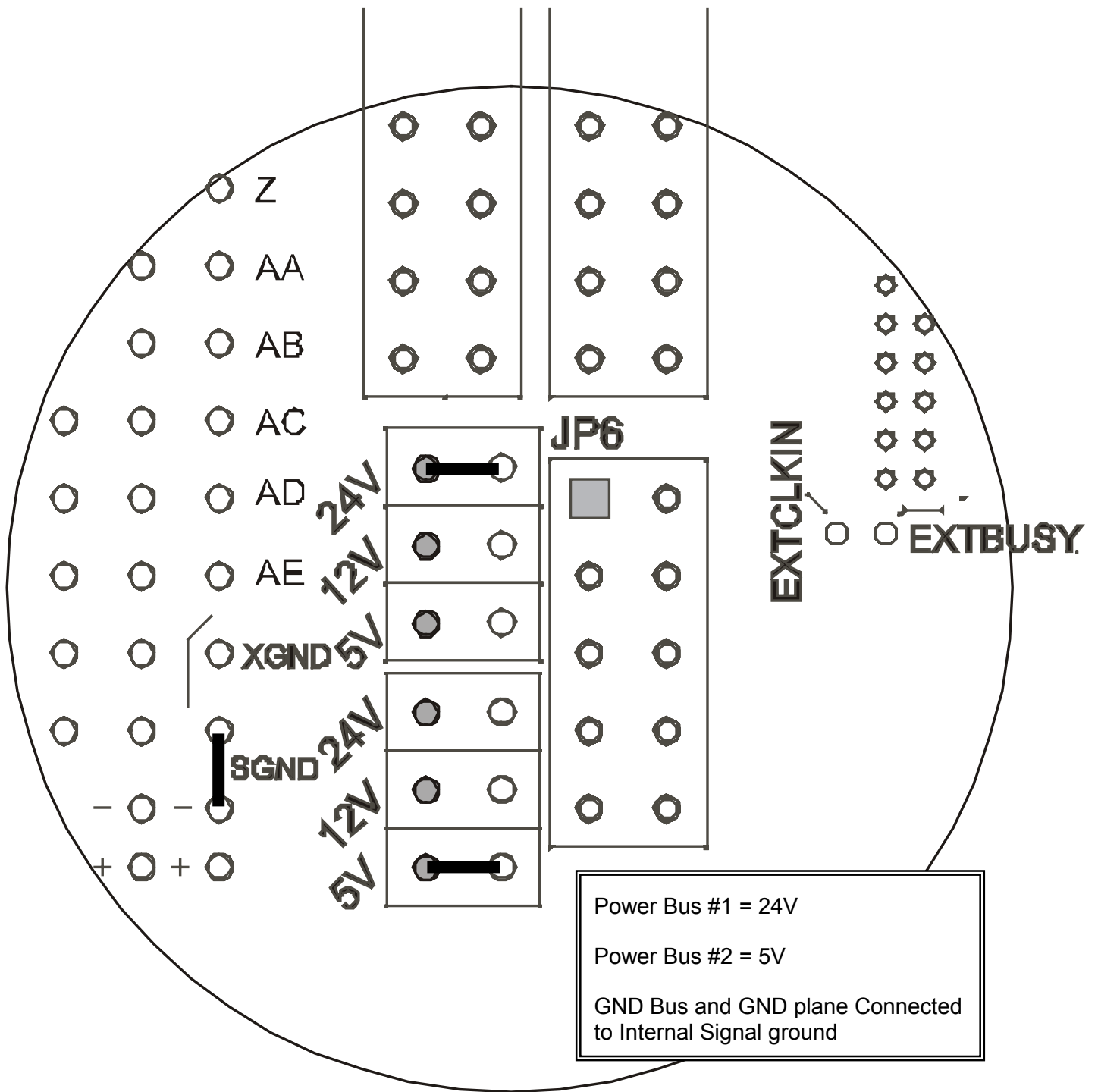

Figure 1-6a, 1260-700 Prototype Power Connection Example

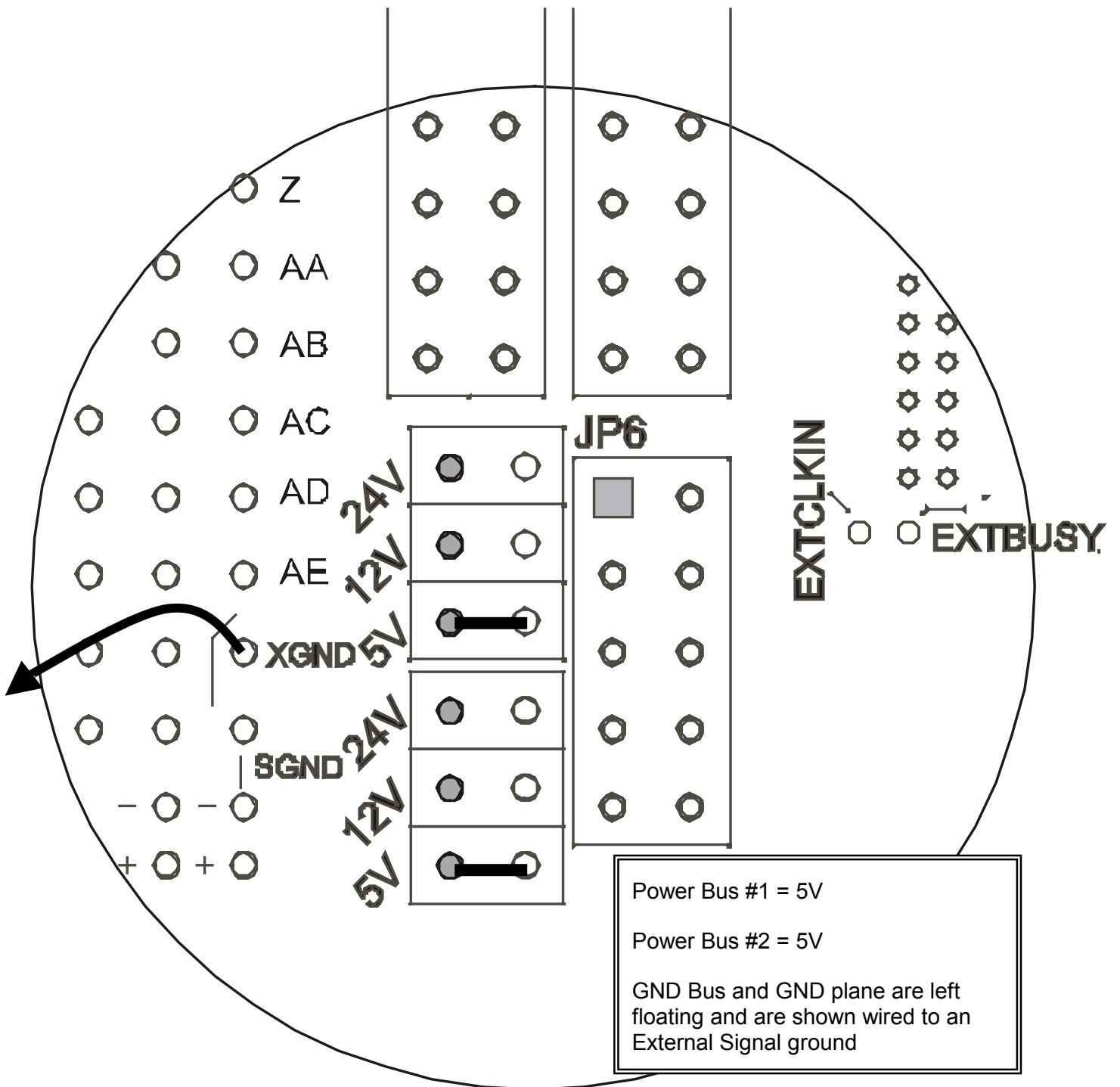

Figure 1-6b, 1260-700 Prototype Power Connection Example

signals and the 5V power. By soldering a jumper wire from the **SGND** pad to the last "■" pad on the lower Ground bus, the internal signal ground will be connected to the ground plane and the ground bus. This configuration is shown in **Figure 1-6a**.

If no jumper wire is soldered, the ground plane and ground bus are left floating. In this configuration, the ground bus may be connected to an external ground signal. This connection may be made to the **XGND** pad as shown in **Figure 6b**, or to any other point along the Ground Bus.

There are two independent power buses on the prototyping board: Bus #1 located at the top (when the front panel is to the right) and Bus #2 at the bottom. By placing a jumper wire at the 24V, 12V or 5V pads, then each bus may be connected to 24V, 12V or 5V respectively.

---

**NOTE**

**+24 Volts and +12 Volts are only available when the 1260-700 is installed in a 1260-100 VXI Adapt-a-Switch™ Carrier.**

---

In the example shown in **Figure 1-6a**, Power Bus #1 is connected to +24 volts, Power Bus #2 is connected to +5 Volts and the Ground Bus and ground plane are connected to the internal signal ground.

In the next example, shown in **Figure 1-6b**, both Power Bus #1 and Power Bus #2 are connected to +5 Volts. The Ground Bus and ground plane are left floating and are shown wired to an external signal ground. Note that in this configuration, last "■" pad on the lower Ground bus is still connected to the internal signal ground and should not be used.

## Prototype Board - Specifications

	<u>Prototype Board</u>
Shock	30g, 11 ms, ½ sine wave
Vibration	0.013 in. P-P, 5-55 Hz
Bench Handling	4 in., 45°
Cooling	See "Power Dissipation / Cooling Guidelines"

Temperature	
Operating	0°C to +55°C
Non-operating	-40°C to +75°C
Relative Humidity	85% + 5% non-condensing at < 30°C
Altitude	
Operating	10,000 feet
Non-operating	15,000 feet
Weight	3 oz. (85 kg.) (No components installed)
Mean Time Between Failures (MTBF)	>1000 Insertions of prototype board to main board  >100,000 hours for the main board (MIL-HDBK-217E)
Mean Time to Repair	< 5 minutes (MTTR)

### **Prototype Board - Power Dissipation / Cooling Guidelines**

Please refer to the Power Dissipation and Cooling Guidelines section for the main board.

### **Component Placement**

Within the 1260-700 prototyping board, components should be placed to allow as much air flow as possible around critical components. When installed in a 1260-100 VXI Adapt-a-Switch™ Carrier, the card will be oriented vertically with the components to the right. Air should be allowed to flow from bottom to top in as unrestricted a manner as possible.

When installed in 1256 chassis, the card will be oriented horizontally with the components on top. Air will flow from right to left across the card.

### **Component Height and Keepout Area**

To maintain compliance with the Racal Instruments Adapt-a-Switch™ and GPIB platforms, the maximum allowable component height for the 1260-700 prototyping card is:

0.500"	top (component) side
0.070"	bottom (solder) side

In order to accommodate the card guides in either a 1256 chassis or a 1260-100 carrier, there is a Keepout area of 0.08" along the top and bottom of the prototype board area

A dimensioned drawing of the prototype PCB may be found in Chapter 4. This drawing should be used to provide the mechanical dimension information needed to layout a custom PCB.

### About MTBF

The 1260-700 MTBF is 783,668 hours, calculated in accordance with MIL-HDBK-217E.

### 1260-700 Block Diagram

A block diagram of the 1260-700 is shown in **Figure 1-7**. The diagram shows the major functional blocks of the digital interface portion of the 1260-700 card.

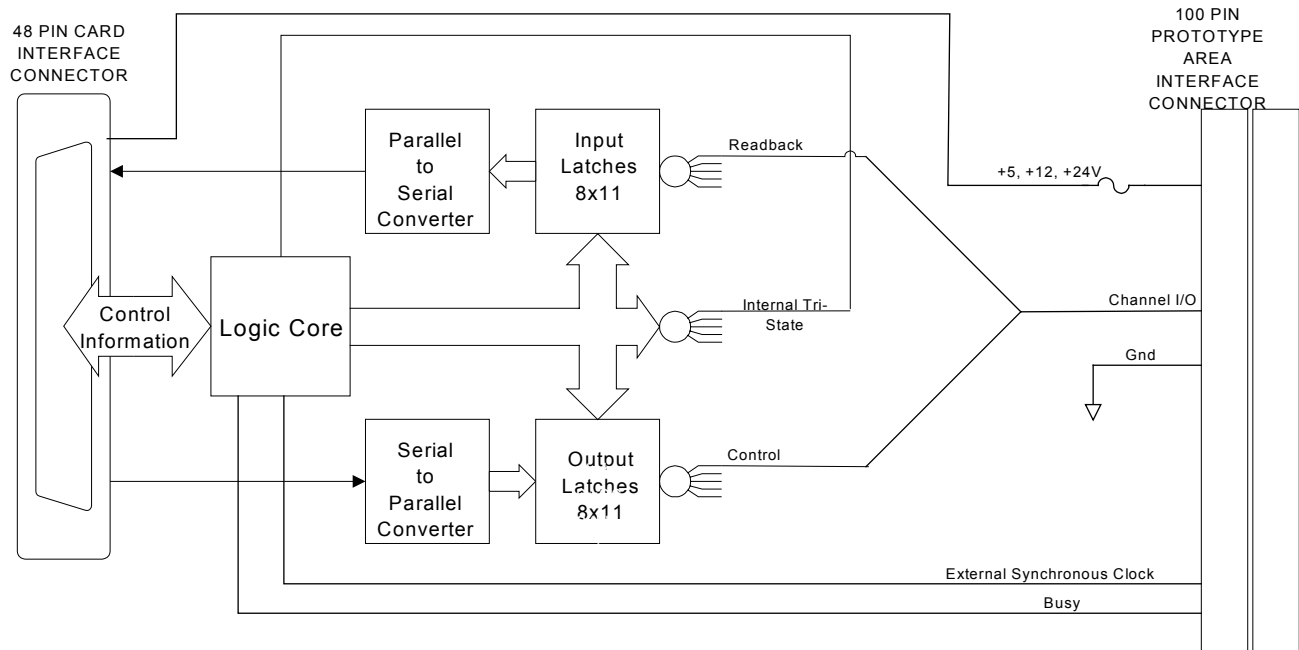

Figure 1-7, 1260-700 Block Diagram



## INSTALLATION INSTRUCTIONS

---

### Unpacking and Inspection



1. Before unpacking the switching module, check the exterior of the shipping carton for any signs of damage. All irregularities should be noted on the shipping bill and reported.

---

**CAUTION**

**ESD sensitive devices, open the instrument at an ESD safe work station.**

---

2. Remove the instrument from its carton, preserving the factory packaging as much as possible.
3. Inspect the switching module for any defects or damage. Immediately notify the carrier if any damage is apparent.
4. Have a qualified person check the instrument for safety before use.

### Reshipment Instructions

1. Use the original packing material when returning the switching module to Racal Instruments for servicing. The original shipping carton and the instrument's plastic foam will provide the necessary support for safe reshipment.
2. If the original packing material is unavailable, wrap the switching module in an ESD Shielding bag and use plastic spray foam to surround and protect the instrument.
3. Reship in either the original or a new shipping carton.

### Assembly

The 1260-700 is shipped with the main board and prototype board disassembled. After putting your own circuitry onto the prototype board, it needs to be attached to the main board.

The prototype board attaches to the main board at the 100-Pin interface connector. Two small brackets are attached to the main

board. Connect the prototype board and main board together. Using the screws provided attach the brackets to the prototype board. It is important to attach the brackets using the screws provided to avoid placing undue stress on the 100-Pin interface connector. See **Figure 2-1**.

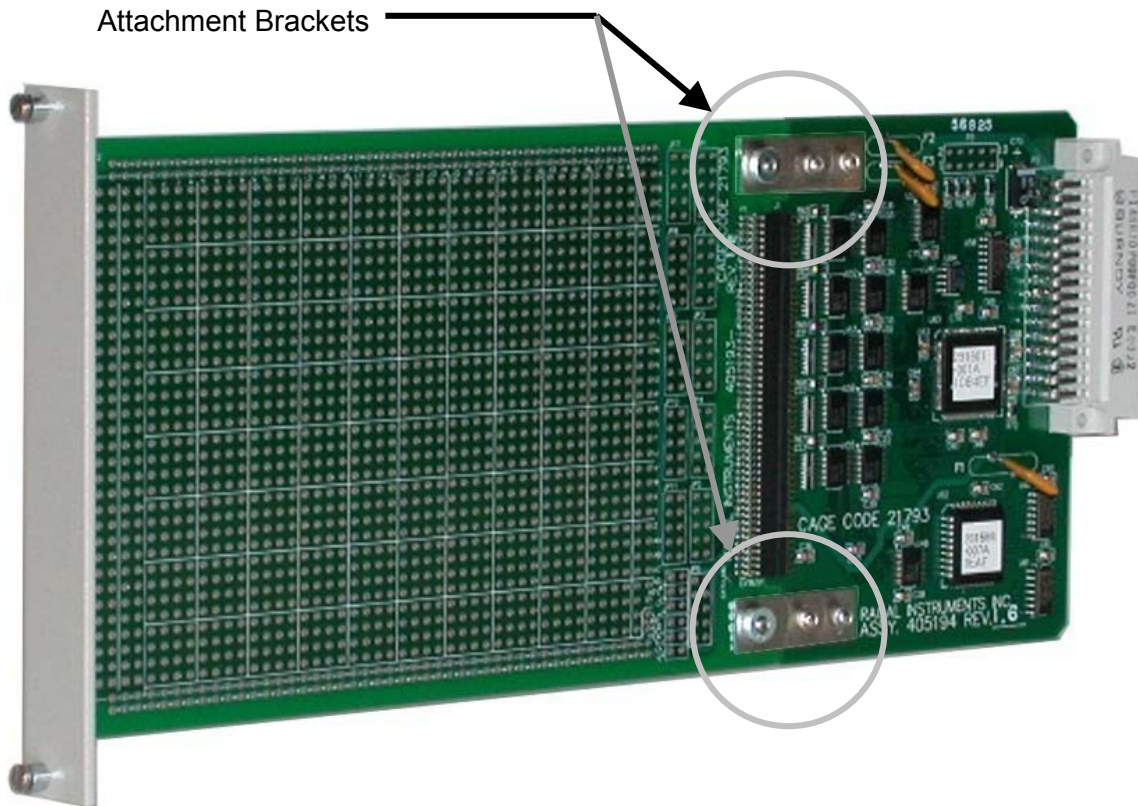

**Figure 2-1, Attachment Bracket Locations**

## Installation

Installation of the 1260-700 Switching Module into a 1260-100 Carrier assembly is described in the Installation section of the 1260-100 Adapt-a-Switch™ Carrier Manual. Installation of the 1260-700 into a 1256 Switching System Mainframe is described in the installation section of the 1256 Switching System Manual.

## Optional Extender Board

As an aid in developing and testing your circuitry on the 1260-700 prototype board, an extender board is available as an optional accessory from Racal Instruments. When used, the extender will allow access to the 1260-700 (or any Adapt-a-Switch™ module) while installed in either a 1256 chassis or a 1260-100 Adapt-a-Switch™ VXI carrier. A diagram of the extender board is shown in **Figure 2-2**.

The extender board carries all backplane signals and power to the 1260-700. Ground pins are available at the front of the extender board for easy access. Card guides are installed onto the extender to add support to the extended 1260-700 card.

When used in a 1256 chassis, the Adapt-a-Switch cards sit horizontally. It is recommended that the card be supported at its far end to avoid putting any undo stress on the connectors.

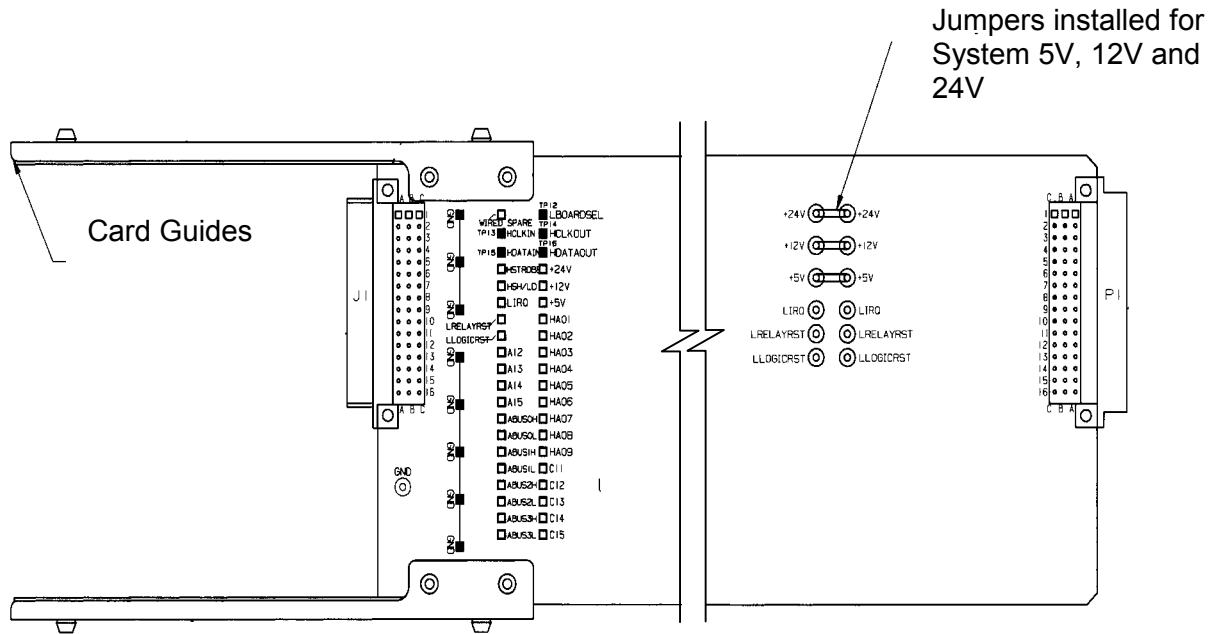

Figure 2-2, Optional Extender Board

## Module Configuration

The 1260-700 is an 88-channel digital I/O prototyping plug-in for the Adapt-a-Switch™ Series. Its architecture permits any 8-bit port to be defined through software as in input or output in either asynchronous or synchronous operational mode.



### NOTE

Since the 1260-700 Digital Interface is based upon Racal Instrument's 1260-114TTL DIO Module, the 1260-700 responds as if it were a 1260-114TTL

---

## Front Panel Connectors

The standard 1260-700 comes with a blank front panel and no front panel connector. As an option, connectorized front panels may be ordered for the 1260-700. Either a two-row, 64-pin connector or a five-row, 160-pin connector may be ordered. Both connectors are industry standard DIN style with 0.025" square post pins placed on a 0.1" grid.

The front panels for these two connector options are shown in **Figure 2-3**.

All front panel kits are shipped with appropriate mounting hardware.

---

## Mating Connectors

Mating connector accessories are available for the 160-Pin and 64-Pin Front Panel connector options:

P/N 407664      160-Pin Connector Kit with backshell and pins,

P/N 407408-001    160-Pin Cable Assembly, 6 Ft., 24 AWG

The 160-Pin Connector Kit consists of a connector housing, and 170 crimp pins. After wire attachment, the pin is inserted into the housing and will snap into place, providing positive retention.

The suggested hand tool for the crimp pins is P/N 990898. The corresponding pin removal tool is P/N 990899.

The 160-Pin Cable Assembly uses 24 AWG cable with crimp pins to mate with the 1260-700 160-Pin Front Panel Connector Option. The other cable end is un-terminated.

P/N 602004      64-Pin DIN IDC Connector

P/N 602159-064    64-Pin DIN Crimp Connector Body

P/N 602159-900    DIN Crimp Pins for 64-Pin Connector Body

The 64-Pin IDC cable accepts standard 64 conductor, 28 AWG flat ribbon cable.

The 64-Pin DIN Crimp Connector body allows for discrete wire connections. The discrete pins are ordered separately. After wire attachment, the pin is inserted into the housing and will snap into place, providing positive retention.

The suggested hand tool for the crimp pins is P/N 990898. The corresponding pin removal tool is P/N 990899.

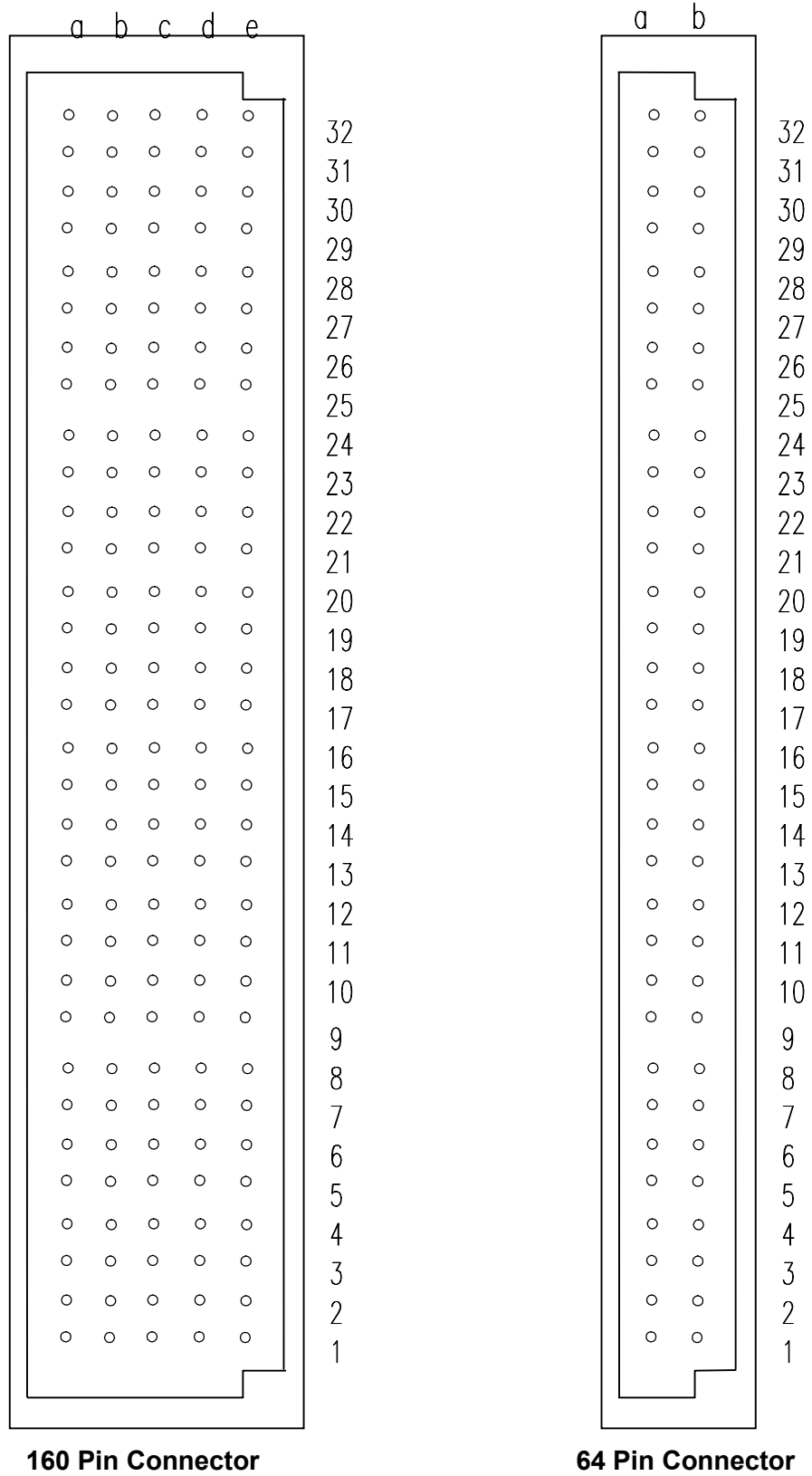

Figure 2-3, Front-Panel Connector Pin Numbering

This page was left intentionally blank.

## Chapter 3

# MODULE OPERATION

### Setting the Module Address

When the 1260-700 is installed in a 1260-100 Adapt-a-Switch™ Carrier, the Option-01T switch controller identifies each Adapt-a-Switch™ plug-in or conventional 1260-Series module by a *module address* that is unique to that module. The module address is a number from 1 through 12, inclusive.

The module address assigned to the 1260-700 depends on the carrier slot into which the 1260-700 is inserted, and on the position of the logical address DIP switch on the carrier side panel. The switch has two settings:

- 1-6 (closed): When the switch is set to this position, the module addresses of the plug-ins in the 1260-100 Carrier are from 1 through 6. The module with address 1 is in the left slot of the top row. The plug-ins are addressed in the following pattern:

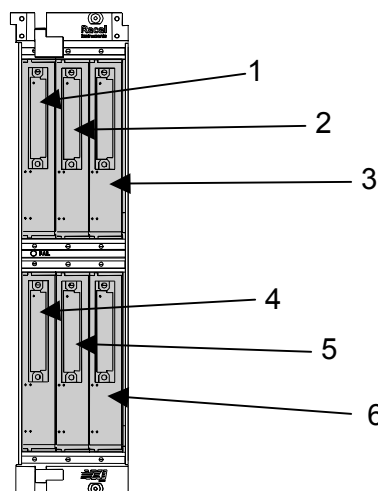
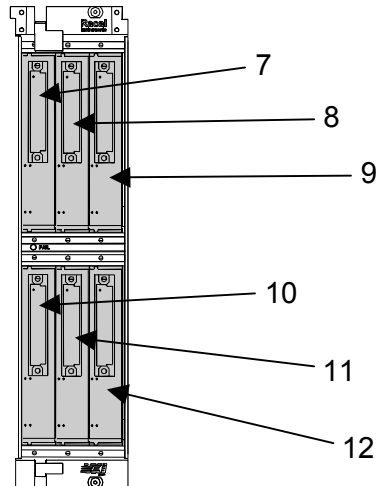

Figure 3-1a, Front View – Module Addresses for 1 through 6 in a 1260-100 Carrier

- 7 - 12 (open): When the switch is set to this position, the module addresses of the plug-ins in the 1260-100 Carrier are from 7 through 12, in the following pattern:



**Figure 3-1b, Front View – Module Addresses for 7 through 12 in a 1260-100 Carrier**

When setting module addresses for Adapt-a-Switch™ Carriers and conventional 1260-Series modules, be sure that no address is used by more than one plug-in or 1260-Series module.

For instructions on setting module addresses for a conventional 1260-Series module, see the label on the side panel of the module.

When the 1260-700 is installed in a 1256 Chassis, the 1256 backplane switch controller identifies each Adapt-a-Switch™ plug-in by a *module address* that is unique to that module. The module address is a number from 1 through 8, inclusive. Please refer to **Figure 3-2**.

The module address assigned to the 1260-700 depends on the slot into which the 1260-700 is inserted.

## Operating Modes

The 1260-700 may be operated either in *message-based* mode or in *register-based* mode.

In the *message-based* mode, the 1260-01T switch controller interprets commands sent by the slot 0 controller, and determines the appropriate data to send to the control registers of the 1260-700 module.



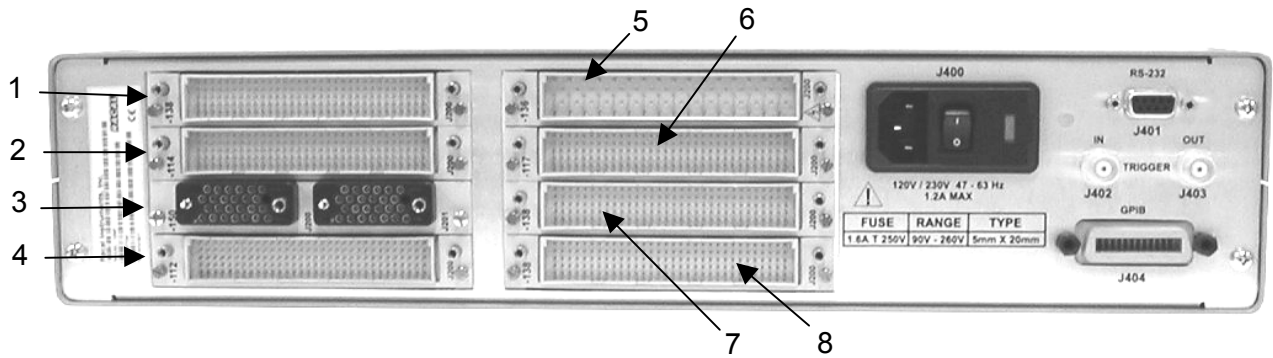

Figure 3-2, Numbering of Switch Plug-In Slots in a 1256 Chassis

For example, if the A24 VXI base address for the 1260-100 Adapt-a-Switch™ carrier is assumed to be at 0x804000A for example purposes and the 1260-700 occupies the module 0 slot, **Figure 3-3** below provides a conceptual view of the -based mode of operation for a read operation on port 1.

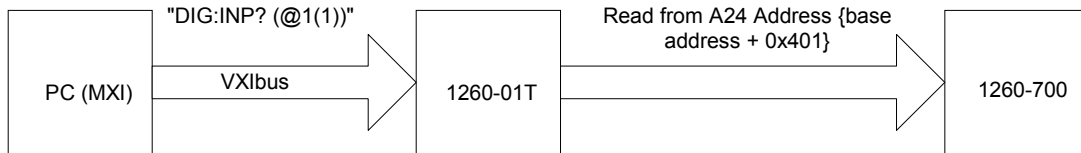

Figure 3-3, Message-Based Mode of Operation

In the *register-based* mode, the user writes directly to the port registers on the 1260-700 module. The 1260-01T command module does not monitor these operations, and does not keep track of the port states on the 1260-700 module in this mode.

A conceptual view of the register-based mode is shown in **Figure 3-4** below.

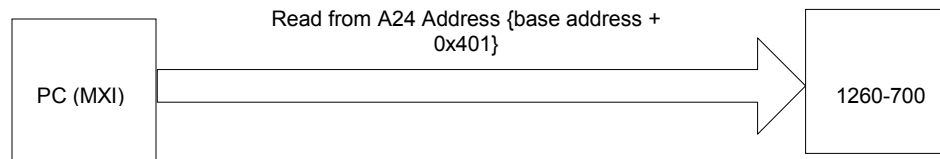

Figure 3-4, Register-Based Mode of Operation

---

**NOTE**

**Register-Based mode is only available when the 1260-700 is installed in a 1260-100 Adapt-a-Switch™ Carrier with an Option 01T.**

---

Since the 1260-01T switch controller does not keep track of port and control register states during the register-based mode, it is advisable to use **either** the message-based or the register-based mode consistently, and use the chosen mode exclusively throughout the application program.

In general, the message-based mode of operation is easier to use with utility software such as the National Instruments VXI Interactive Control (VIC) program. The message-based mode allows the user to send ASCII text commands to the 1260-01T or 1256 and to read replies from the 1260-01T or 1256. In addition, some features, such as synchronous port operation, are available only in the message-based mode. An added benefit of message-based operation is that it obviates the need to manually configure control registers on the 1260-700, controlling such things as port data direction, since these are handled automatically by the 1260-01T or 1256.

The register-based mode provides faster and more direct control of the 1260-700. In this mode, direct port and control register operations are processed in less than 9 microseconds, not counting software overhead inherent in I/O libraries such as VISA.

For further information about message-based vs. register-based comparisons, consult the 1260-01T User's Manual

## Operating In Message-Based Mode

---

### Port Descriptors For The 1260-700

The standard 1260-01T and 1256 commands are used to operate the 1260-700 module. These commands are described in the 1260-01T and 1256 User's Manuals.

Each 1260-01T or 1256 port command uses a *port descriptor* (also referred to as a *channel descriptor* in some documentation) to select the port(s) of interest. The syntax for a port descriptor is the same for all 1260 series modules. In general, the following syntax is used to select a single port:

(@ <module address> ( <port> ) )

Where:

- <module address> is the address of the 1260-700 module. This is a number in the range from 1 through 12, inclusive.
- <port> is the 1260-700 port to operate. This is a number in the range from 0 through 11, inclusive.

---

**NOTE**

**Since the 1260-700 is based upon Racal Instrument's 1260-114 Digital I/O Module, the 1260-700 will respond as if there were 12 ports (0-11) However, the twelfth port is not physically implemented.**

---

Multiple individual ports may be specified using the following port descriptor syntax:

```
@ <module address> ( <port1> , <port2>
, . . . , <portN> ) [,data]
```

A range of ports may be specified using the following channel descriptor syntax:

```
@ <module address> ( <first port> :
<last port> )
```

The following examples illustrate the use of the port descriptors for the 1260-700:

```
DIG:OUTP (@8(0)),234  Writes 234d to port 0 at
                        module address 8
```

```
DIG:INP? (@3(1))    Reads port 1 at module address 3
```

---

## Reply To The MOD:LIST? Command



---

**NOTE**

**Since the 1260-700 Digital Interface is based upon Racal Instrument's 1260-114TTL DIO Module, the 1260-700 responds as if it were a 1260-114TTL**

---

The 1260-01T or 1256 returns a reply to the MOD:LIST? command. This reply is unique for each different 1260 series switch module. The syntax for the reply is:

```
<module address> : <module-specific identification string>
```

Since the 1260-700 is based upon Racal Instrument's 1260-114TTL module, the <module-specific identification string> for the 1260-700 responds like the 1260-114TTL as:

```
1260-114TTL DIGITAL INPUT/OUTPUT TTL MODULE
```

So, for a 1260-700 whose <module address> is set to 8, the reply to this query would be:

```
8 : 1260-114TTL DIGITAL INPUT/OUTPUT TTL
MODULE
```

## Operating The 1260-700 in Register-Based Mode

---

### NOTE

**Register-Based mode is only available when the 1260-700 is installed in a 1260-100 Adapt-a-Switch™ Carrier with an Option 01T.**

---

In register-based mode, the 1260-700 is operated by directly writing and reading to port and control registers on the 1260-700 module. To access the various registers, the following details must be assembled to generate an absolute address that can be written to or read from:

The port and control registers are located in the VXIbus A24 Address Space. The A24 address for a port or control register depends on:

1. The A24 Address Offset assigned to the 1260-01T module by the Resource Manager program. The Resource Manager program is provided by the VXIbus slot-0 controller vendor. The A24 Address Offset is placed into the "Offset Register" of the 1260-01T by the Resource Manager.
2. The <module address> of the 1260-700 module. This is a value in the range from 1 and 12 inclusive.
3. The 1260-700 port or control register to be written to or read from. Each register on the 1260-700 has a unique offset from the base address.

The base A24 address for the 1260-700 module may be calculated by:

$$(A24 \text{ Offset of the } 1260-01T) + (1024 \times \text{Module Address of } 1260-700).$$

The A24 address offset is usually expressed in hexadecimal. A typical value of  $204000_{16}$  is used in the examples that follow.

A 1260-700 with a module address of 7 would have the base A24 address computed as:

$$\begin{aligned} \text{Base A24 Address of 1260-700} &= 204000_{16} + (400_{16} \times 7_{10}) \\ &= 205C00_{16} \end{aligned}$$

The port and control registers for Adapt-a-Switch™ plug-ins and conventional 1260-Series modules are always on odd-numbered A24 addresses. For port registers, the 1260-700 reads and writes to the same location. For control registers, the 1260-700 writes to one location, but reads back from another. **Table 3-1** provides offsets relative to the base address of the module for all port and control registers of the 1260-700.

---

**Note**

**The 1260-700 will respond as if there were a twelfth port (Port L) even though this port is not physically implemented.**

---

To obtain the absolute address where data is to be written or read from, the base address is added to the offset:

$$(\text{Base A24 1260-700 Address}) + \text{offset} = \text{absolute address}$$

So, for our example base A24 address computed earlier, the following absolute addresses would apply for the operations indicated:

205C01	Port 0 read or written at this location
205C19	Control Register 1 written at this location
205E03	Control Register 1 read at this location

Before explaining the particulars of reading and writing to port and control registers, it is necessary to understand how the registers interact with the 1260-700. **Table 3-2** provides a detailed explanation of each register and how it interacts with the 1260-700 module.

Register Name	Register Offsets to Add to Base Module Address	
	Write Location (hexadecimal)	Read Location (hexadecimal)
Port A (Port 0)	0x01	0x01
Port B (Port 1)	0x03	0x03
Port C (Port 2)	0x05	0x05
Port D (Port 3)	0x07	0x07
Port E (Port 4)	0x09	0x09
Port F (Port 5)	0x0B	0x0B
Port G (Port 6)	0x0D	0x0D
Port H (Port 7)	0x0F	0x0F
Port I (Port 8)	0x11	0x11
Port J (Port 9)	0x13	0x13
Port K (Port 10)	0x15	0x15
Port L (Port 11)*	0x17	0x17
ID	Read Only	0x201
Control Register 1	0x19	0x203
Control Register 2	0x1B	0x205
Control Register 3	0x1D	0x207
EPROM Descriptor	Read Only	0x301

\* Port L is not physically implemented in the 1260-700

**Table 3-1, Register Offset Addresses of the 1260-700 Module**

Register Table		ID Register
Module Version	Bit	Functionality Description
1260-700	0	Always Reads 0x00 (Read Only)
	1	
	2	
	3	
	4	
	5	
	6	
	7	

**Table 3-2, ID Register Functionality of the 1260-700**

Register Table		Ports A-F
Module Version	Bit	Functionality Description
1260-700	0	Each port is an 8-bit register where the lowest order bit corresponds to lowest order connector pin of the port group. A '1' written to any bit drives the appropriate output driver high while a '0' drives the appropriate output driver low. If a port is read, the data will appear identical to what was written to the register.
	1	
	2	
	3	
	4	
	5	
	6	
	7	

**Table 3-3, Ports A-F Register Functionality of the 1260-700 Module**

Register Table		Ports G-L
Module Version	Bit	Functionality Description
1260-700	0	Each port is an 8-bit register where the lowest order bit corresponds to lowest order connector pin of the port group. A '1' written to any bit drives the appropriate output driver high while a '0' drives the appropriate output driver low. If a port is read, the data will appear identical to what was written to the register.
	1	
	2	
	3	
	4	
	5	
	6	
	7	

NOTE: The 1260-700 will accept data written to Port L, though the port is not physically implemented.

**Table 3-4, Ports G-L Register Functionality of the 1260-700 Module**

Register Table		Control Register 1	
Module Version	Bit	Functionality Description	
1260-700 (As written to register: bits normally read inverted)	0	0: Port A Input Port	1: Port A Output Port
	1	0: Port B Input Port	1: Port B Output Port
	2	0: Port C Input Port	1: Port C Output Port
	3	0: Port D Input Port	1: Port D Output Port
	4	0: Port E Input Port	1: Port E Output Port
	5	0: Port F Input Port	1: Port F Output Port
	6	0: Port G Input Port	1: Port G Output Port
	7	0: Port H Input Port	1: Port H Output Port

**Table 3-5, Control Register 1 Functionality of the 1260-700 Module**



Register Table		Control Register 2	
Module Version	Bit	Functionality Description	
1260-700 (As written to register: bits 0-3 normally read inverted)	0	0: Port I Input Port	1: Port I Output Port
	1	0: Port J Input Port	1: Port J Output Port
	2	0: Port K Input Port	1: Port K Output Port
	3	0: Port L Input Port	1: Port L Output Port
	4	Bits 4-7 control whether ports A-L act in synchronous or asynchronous mode. Bits 4-7 enable synchronous mode for the port specified and all lower order ports while higher ports are set to asynchronous mode (i.e. 0x0 = all ports asynchronous, 0xB = all ports synchronous, 0x3 = ports A-C synchronous)	
	5		
	6		
	7		

Table 3-6, Control Register 2 Functionality of the 1260-700 Module

Register Table		Control Register 3	
Module Version	Bit	Functionality Description	
1260-700	0	0: Disable Interrupts	1: Enable Interrupts
	1	0: Ext. Busy Active Low	1: Ext. Busy Active High
	2	0: Ext. Clock Active + Edge	1: Ext. Clock Active - Edge
	3	0: Reserved	1: Reserved
	4	0: Reserved	1: Reserved
	5	0: Ext. Trigger Not Active (Read Only)	1: Ext. Trigger Active (Read Only)
	6	0: Interrupt Service Required (Read Only)	1: Interrupt Service Not Required (Read Only)
	7	0: Module Is Asserting Interrupt Line (Read Only)	1: Module Is Not Asserting Interrupt Line (Read Only)

Table 3-7, Control Register 3 Functionality of the 1260-700 Module

Register Table		EPROM Descriptor Register
Module Version	Bit	Functionality Description
1260-700	0	This register each time read advances a memory pointer to the next memory location in an EPROM. To reset this pointer to the beginning, simply read the ID register and the memory pointer resets to zero. The descriptor register contains a long string of data, typically used by the Adapt-a-Switch™ carrier for configuration purposes. Additionally, this data has the card identification string for the specific type of card (i.e. 1260-114TTL). This identification strings are located at EPROM memory locations 0x23-0x34
	1	
	2	
	3	
	4	
	5	
	6	
7		

**Table 3-8, EPROM Descriptor Functionality of the 1260-700 Module**

Writing to a port location is a straightforward process. Setting a bit high in a port register causes the port to output a high logic level on the port pin corresponding to that bit. In the case of an open-collector version, this same operation would cause the pull-down transistor to activate.

It is especially important to realize that a single write operation controls eight separate control lines or output devices simultaneously. Therefore if only a single bit change is desired, the following process must be observed.

1. Read the register first, inverting the bit pattern if necessary.
2. Mask the appropriate bit with an 'AND' operation and a byte mask with all undesired bits set to a '1' and the desired bit set to a '0' or '1' depending on whether the bit is to be set or cleared in the desired register.
3. Write the masked data back into the register.

As simple as this may seem, a number of products reported as faulty and sent back for repair are nothing more than the result of inappropriate register accesses.

Reading a 1260-700 register has a few details that must also be considered. Some registers when read, provide data that is inverted from that written to the register in an earlier operation. Tables 3-1 through 3-8 indicate whether bit inversion occurs for a particular register of the 1260-700.

The VISA I/O library may be used to control the module. The VISA function *viOut8()* is used to write a single 8-bit byte to a control register, while *viIn8()* is used to read a single 8-bit byte from the control register. The following code example shows the use of *viOut8()* to update the 1260-700 module.

## 1260-700 Example Code

The following code example is applicable to the 1260-700 operating in register mode and controlled by a 1260-01T.

```
#include <visa.h>

/* This example shows a 1260-01T at logical address 16 and a VXI/MXI */
/* interface */
#define RI1260_01_DESC      "VXI::16"

/* For a GPIB-VXI interface, and a logical address of 77 */
/* the descriptor would be: "GPIB-VXI::77" */

/* this example shows a 1260-700 with module address 7, port 1,
and write data of 0xAA */
#define MOD_ADDR_700      7
#define PORT_NUMBER      1
#define DATA_ITEM        0xAA

void example_operate_1260_700(void)
{
    ViUInt8 creg_val;
    ViBusAddress portA_addr, offset;
    ViSession hdl1260;    /* VISA handle to the 1260-01T */
    ViSession hdlRM;      /* VISA handle to the resource manager */
    ViStatus error;      /* VISA error code */

    /* open the resource manager */
    /* this must be done once in application program */
    error = viOpenDefaultRM (&hdlRM);

    if (error < 0) {
        /* error handling code goes here */
    }

    /* get a handle for the 1260-01T */
    error = viOpen (hdlRM, RI1260_01_DESC, VI_NULL,VI_NULL, &hdl1260);
    if (error < 0) {
        /* error handling code goes here */
    }

    /* form the offset for control register 0 */

```

```
/* note that the base A24 Address for the 1260-01T */
/* is already accounted for by VISA calls viIn8() and */
/* viOut8() */

/* module address shifted 10 places = module address x 1024 */
portA_addr = (MOD_ADDR_700 << 10) + 1;
offset = portA_addr + (PORT_NUMBER << 1);

error = viOut8 (vi, VI_A24_SPACE, offset, DATA_ITEM);

if (error < 0)

    return( error );

/* close the VISA session */
error = viClose( hdl1260 );
if (error < 0) {
    /* error handling code goes here */
}
}
```

This page was left intentionally blank.

**Chapter 4**  
**DRAWINGS**

---

457062	Prototype Board Outline drawing.....	4-2
405193	PCB Assy, 1260-700 Prototype Board.....	4.4

ZONE	REV	DESCRIPTION	DATE	APPROVED
A	1	ISSUE FOR INITIAL RELEASE		
B	1	ISSUE FOR DESIGN		
C	1	ISSUE FOR PRODUCTION		
D	1	ISSUE FOR FINAL RELEASE		

ZONE	REV	DESCRIPTION	DATE	APPROVED
A	1	ISSUE FOR INITIAL RELEASE		
B	1	ISSUE FOR DESIGN		
C	1	ISSUE FOR PRODUCTION		
D	1	ISSUE FOR FINAL RELEASE		

ZONE	REV	DESCRIPTION	DATE	APPROVED
A	1	ISSUE FOR INITIAL RELEASE		
B	1	ISSUE FOR DESIGN		
C	1	ISSUE FOR PRODUCTION		
D	1	ISSUE FOR FINAL RELEASE		

ZONE	REV	DESCRIPTION	DATE	APPROVED
A	1	ISSUE FOR INITIAL RELEASE		
B	1	ISSUE FOR DESIGN		
C	1	ISSUE FOR PRODUCTION		
D	1	ISSUE FOR FINAL RELEASE		

ZONE	REV	DESCRIPTION	DATE	APPROVED
A	1	ISSUE FOR INITIAL RELEASE		
B	1	ISSUE FOR DESIGN		
C	1	ISSUE FOR PRODUCTION		
D	1	ISSUE FOR FINAL RELEASE		

ZONE	REV	DESCRIPTION	DATE	APPROVED
A	1	ISSUE FOR INITIAL RELEASE		
B	1	ISSUE FOR DESIGN		
C	1	ISSUE FOR PRODUCTION		
D	1	ISSUE FOR FINAL RELEASE		

ZONE	REV	DESCRIPTION	DATE	APPROVED
A	1	ISSUE FOR INITIAL RELEASE		
B	1	ISSUE FOR DESIGN		
C	1	ISSUE FOR PRODUCTION		
D	1	ISSUE FOR FINAL RELEASE		

ZONE	REV	DESCRIPTION	DATE	APPROVED
A	1	ISSUE FOR INITIAL RELEASE		
B	1	ISSUE FOR DESIGN		
C	1	ISSUE FOR PRODUCTION		
D	1	ISSUE FOR FINAL RELEASE		

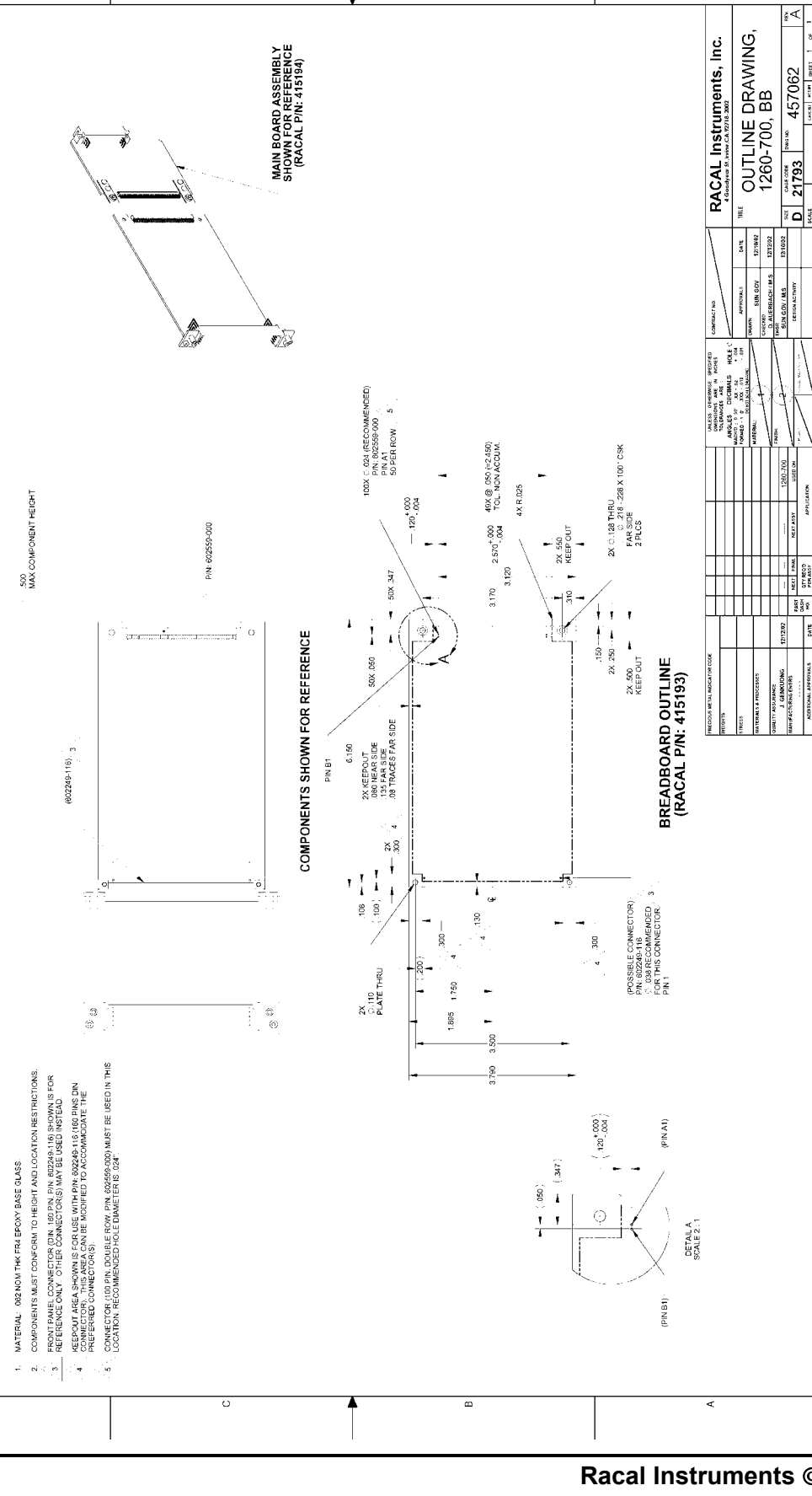

ZONE	REV	DESCRIPTION	DATE	APPROVED
A	1	ISSUE FOR INITIAL RELEASE		
B	1	ISSUE FOR DESIGN		
C	1	ISSUE FOR PRODUCTION		
D	1	ISSUE FOR FINAL RELEASE		

**RACAL Instruments, Inc.**  
**OUTLINE DRAWING, 1260-700, BB**  
 DATE: 04/20/00  
 DRAWN: 21793  
 CHECKED: 457062  
 SCALE: 1:1  
 SHEET 1 OF 1



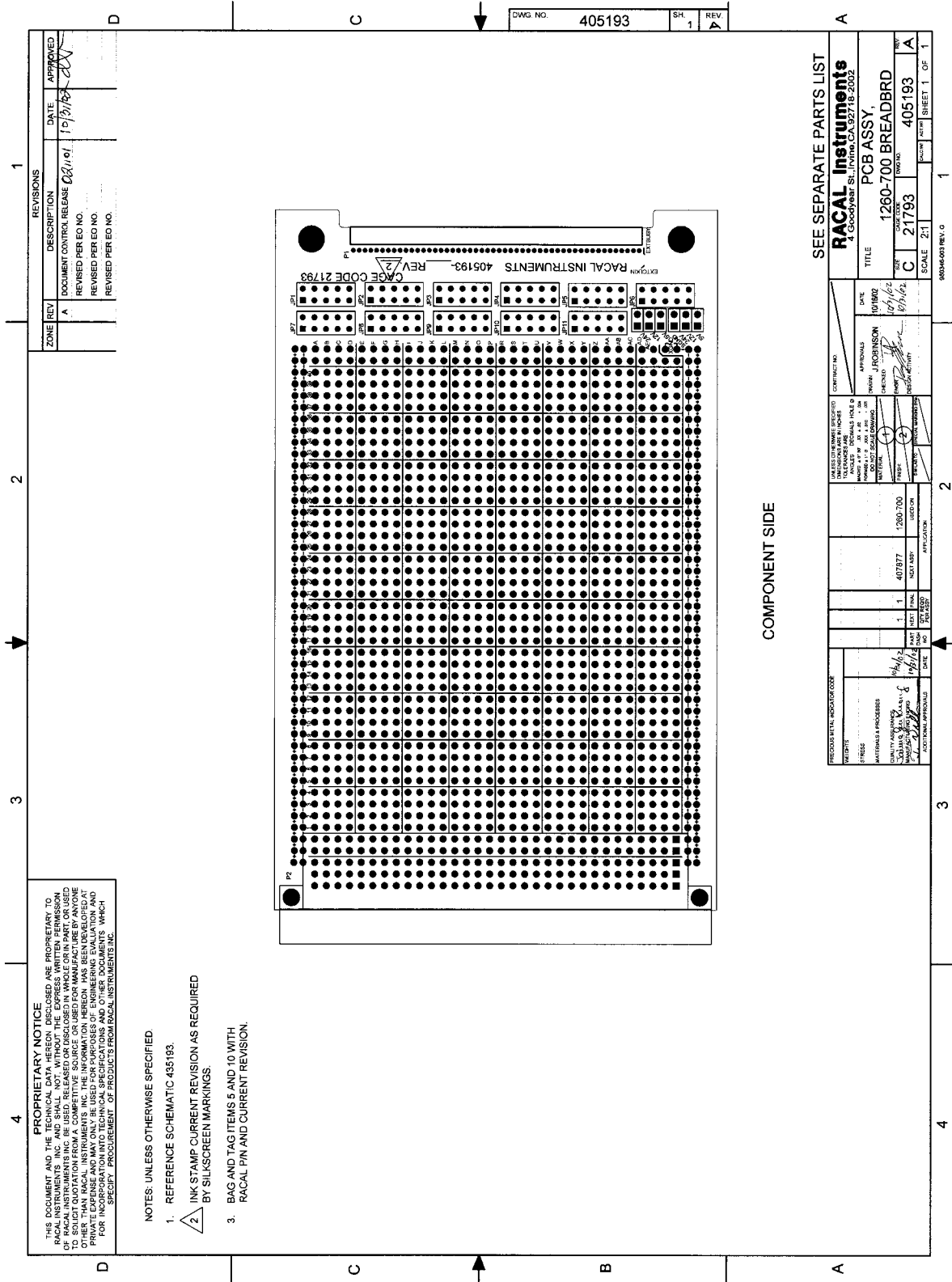

This page was left intentionally blank.

## Chapter 5

# OPTIONAL ASSEMBLIES

---

407664	Connector Kit, 160 Pin Crimp.....	5-3
407408-001	Cable Assy, 160 Pin, 6 ft, 24AWG.....	5-4

This page was left intentionally blank.

RACAL INSTRUMENTS, INC.

Assembly 407664

Connector kit, 160 Pin, Crimp

Rev Date 7/30/98 Revision A

<b>#</b>	<b>Component</b>	<b>Description</b>	<b>U/M</b>	<b>Qty Reqd.</b>	<b>REF</b>
1	602258-116	CON-CAB-RCP160C,100S	-E EA	1.000	
2	602258-900	TRMCRP-SNP-U-F26-20G	-E EA	170.000	

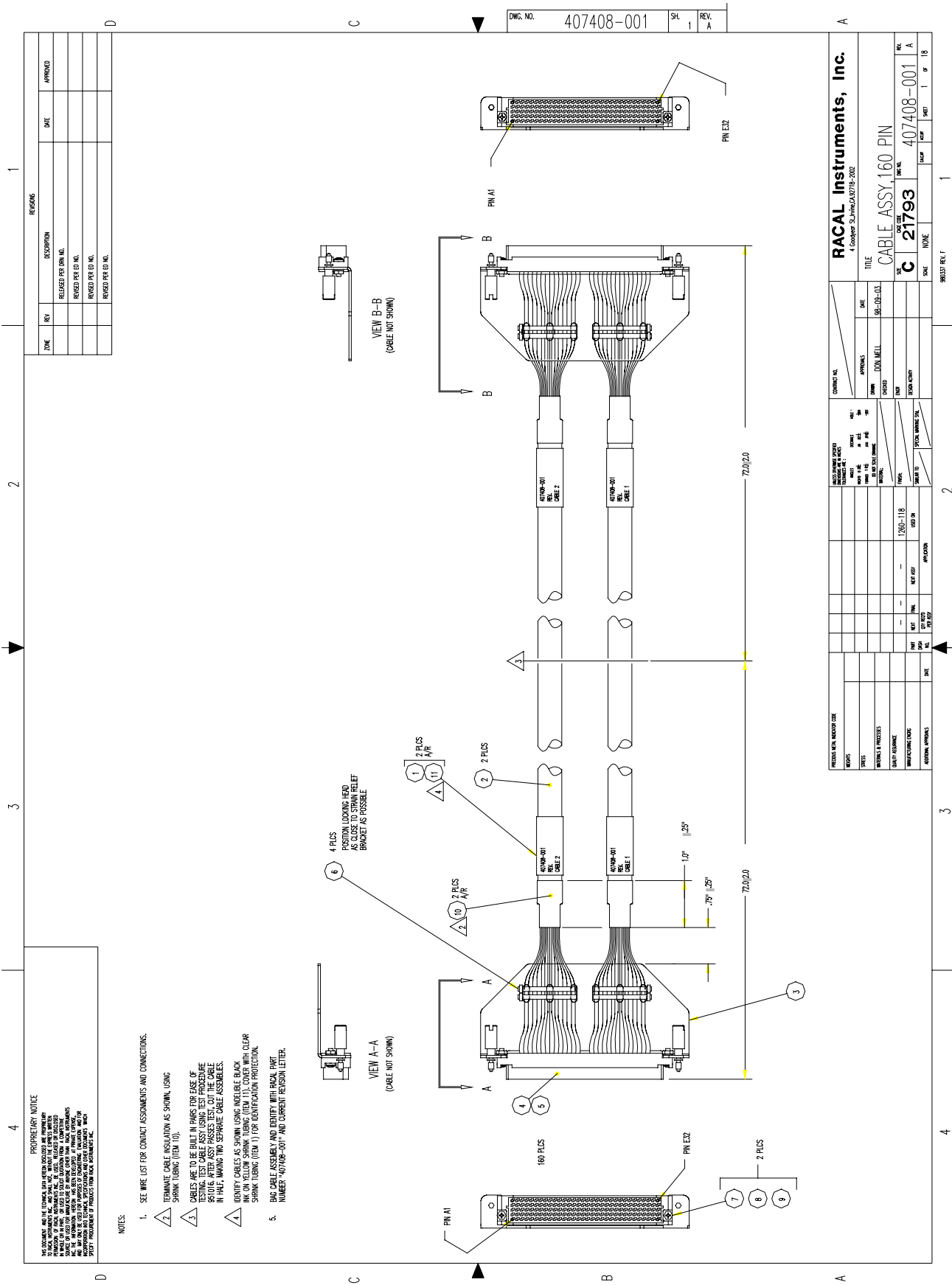

ZONE	REV	DESCRIPTION	DATE	APPROVED
		RELEASED PER DR. NO.		
		REVISED PER DR. NO.		
		REVISED PER DR. NO.		
		REVISED PER DR. NO.		

ZONE	REV	DESCRIPTION	DATE	APPROVED
		RELEASED PER DR. NO.		
		REVISED PER DR. NO.		
		REVISED PER DR. NO.		
		REVISED PER DR. NO.		

- NOTES:
- SEE WIRE LIST FOR CONTACT ASSIGNMENTS AND CONNECTIONS.
  - TERMINATE CABLE INSULATION AS SHOWN, USING SHRINK TUBING (ITEM 10).
  - CABLES ARE TO BE BUILT IN PAIRS FOR EASE OF TESTING. TEST CABLE ASSY USING TEST PROCEDURE 8910116. AFTER ASSY PASSES TEST, CUT THE CABLE IN HALF, MAKING TWO SEPARATE CABLE ASSEMBLIES.
  - IDENTIFY CABLES AS SHOWN USING INDELIBLE BLACK INK ON YELLOW SHRINK TUBING (ITEM 11). COVER WITH CLEAR SHRINK TUBING (ITEM 1) FOR IDENTIFICATION PROTECTION.
  - BAG CABLE ASSEMBLY AND IDENTIFY WITH RACAL PART NUMBER: 407408-001\* AND CURRENT REVISION LETTER.

DWG. NO.	407408-001	SH.	1	REV.	A
----------	------------	-----	---	------	---

<b>RACAL Instruments, Inc.</b>		4 Cooper St., Jamaica, NY 11435-2002	
TITLE		CABLE ASSY, 160 PIN	
DATE	08-03-01	SCALE	1:1
APPROVED		DRW	
DESIGNED	DOUG WELLS	CHECKED	
DRAWN		DATE	
ISSUED		BY	
REVISIONS		BY	
NO.	DATE	BY	REASON
1			
2			
3			
4			
5			
6			
7			
8			
9			
10			
11			
12			
13			
14			
15			
16			
17			
18			
19			
20			
21			
22			
23			
24			
25			
26			
27			
28			
29			
30			
31			
32			
33			
34			
35			
36			
37			
38			
39			
40			
41			
42			
43			
44			
45			
46			
47			
48			
49			
50			
51			
52			
53			
54			
55			
56			
57			
58			
59			
60			
61			
62			
63			
64			
65			
66			
67			
68			
69			
70			
71			
72			
73			
74			
75			
76			
77			
78			
79			
80			
81			
82			
83			
84			
85			
86			
87			
88			
89			
90			
91			
92			
93			
94			
95			
96			
97			
98			
99			
100			

## Chapter 6

# PRODUCT SUPPORT

---

## Product Support

Racal Instruments has a complete Service and Parts Department. If you need technical assistance or should it be necessary to return your product for repair or calibration, call 1-800-722-3262. If parts are required to repair the product at your facility, call 1-949-859-8999 and ask for the Parts Department.

When sending your instrument in for repair, complete the form in the back of this manual.

For worldwide support and the office closes to your facility, refer to the Support Offices section on the following page.

## Warranty

Use the original packing material when returning the 1260-700 to Racal Instruments for calibration or servicing. The original shipping container and associated packaging material will provide the necessary protection for safe reshipment.

If the original packing material is unavailable, contact Racal Instruments Customer Service for information.

## Support Offices

### RACAL INSTRUMENTS

#### United States

(Corporate Headquarters and Service Center)  
4 Goodyear Street, Irvine, CA 92618  
Tel: (800) 722-2528, (949) 859-8999; Fax: (949) 859-7139

5730 Northwest Parkway Suite 700, San Antonio, TX 78249  
Tel: (210) 699-6799; Fax: (210) 699-8857

#### Europe

(European Headquarters and Service Center)  
18 Avenue Dutartre, 78150 LeChesnay, France  
Tel: +33 (0)1 39 23 22 22; Fax: +33 (0)1 39 23 22 25

29-31 Cobham Road, Wimborne, Dorset BH21 7PF, United Kingdom  
Tel: +44 (0) 1202 872800; Fax: +44 (0) 1202 870810

Via Milazzo 25, 20092 Cinisello B, Milan, Italy  
Tel: +39 (0)2 6123 901; Fax: +39 (0)2 6129 3606

Technologie Park, Friedrich Ebert Strasse, 51429 Bergisch Gladbach, Germany  
Tel: +49 (0) 2204 844200; Fax: +49 (0) 2204 844219



## Repair and Calibration Request Form

To allow us to better understand your repair requests, we suggest you use the following outline when calling and include a copy with your instrument to be sent to the Racal Instruments Repair Facility.

Model \_\_\_\_\_ Serial No. \_\_\_\_\_ Date \_\_\_\_\_

Company Name \_\_\_\_\_ Purchase Order # \_\_\_\_\_

Billing Address \_\_\_\_\_

City

State/Province

Zip/Postal Code

Country

Shipping Address \_\_\_\_\_

City

State/Province

Zip/Postal Code

Country

Technical Contact \_\_\_\_\_ Phone Number ( ) \_\_\_\_\_

Purchasing Contact \_\_\_\_\_ Phone Number ( ) \_\_\_\_\_

1. Describe, in detail, the problem and symptoms you are having. Please include all set up details, such as input/output levels, frequencies, waveform details, etc.

---

---

---

---

2. If problem is occurring when unit is in remote, please list the program strings used and the controller type.

---

---

---

---

3. Please give any additional information you feel would be beneficial in facilitating a faster repair time (i.e., modifications, etc.)

---

---

---

---

4. Is calibration data required?      Yes   No   (please circle one)

Call before shipping                      Ship instruments to nearest support office.

Note: We do not accept  
"collect" shipments.

This page was left intentionally blank.